



HoneyPack Pod 2000 Quick Reference User Guide



☎ 844.466.3972

🌐 honeypack.com

OPERATING INSTRUCTIONS

Safety Guidelines

Please read the safety guidelines and operating instruction closely before using the machine.



- Turn off the machine and disconnect power before opening the machine or performing any repair or maintenance work on the machine.
- Switch off the machine if it will not be used for an extended period of time.
- Do not insert any objects into the machine when it is connected to power.
- To prevent the risk of electric shock, ensure that the machine does not come into contact with liquids.



- Do not operate the machine without the covers for the machine components.
- Keep hair and loose clothing away from the film feed mechanism.
- Place the machine only on surfaces that are adequately large, stable, flat, and horizontal.

The machine is designed for safe operation in compliance with the use, instructions, and guidelines specified in these operating instruction.

All persons who use this machine must be familiar with the content of these operating instructions and must carefully follow the safety guidelines.

HoneyPack shall not be responsible for damage resulting from improper use of the machine or non-observance of the safety guidelines.

OPERATING INSTRUCTIONS

Air Cushion Types



48005 - 8" x 4" PolyPack .8mil 2300'

48011 - 8" x 4" PolyPack .8mil 1100'



48032 - 6" x 8.5" PolyPack .8mil 2300'



48006 - 16" Wide 4 Chamber PolyPack

48012 - 16" Wide 4 Chamber PolyPack



48035 - 16" Wide 2 Chamber PolyPack



48034 - 16" Wide 8 Chamber PolyPack



48039 - 8" x 4" PaperPack 2mil 1000'

Recommended Settings

ITEM NUMBER	RECOMMENDED TEMPERATURE (°F)	RECOMMENDED AIR VOLUME (%)
48034	338°F - 356°F	80%
48032	338°F - 356°F	30%
48035	338°F - 356°F	80%
48005	338°F - 356°F	26%
48006	338°F - 356°F	66%
48011	338°F - 356°F	26%
48012	338°F - 356°F	66%
48039	385°F - 390°F	25%

The listed settings are recommendations to ensure a longer life of the machine by still good cushion results. Do not exceed these settings. But temperature and air volume can differ a little bit depending on field of application and environmental conditions.



Scan the code to see other settings for HoneyPack Pod 2000

Machine Overview

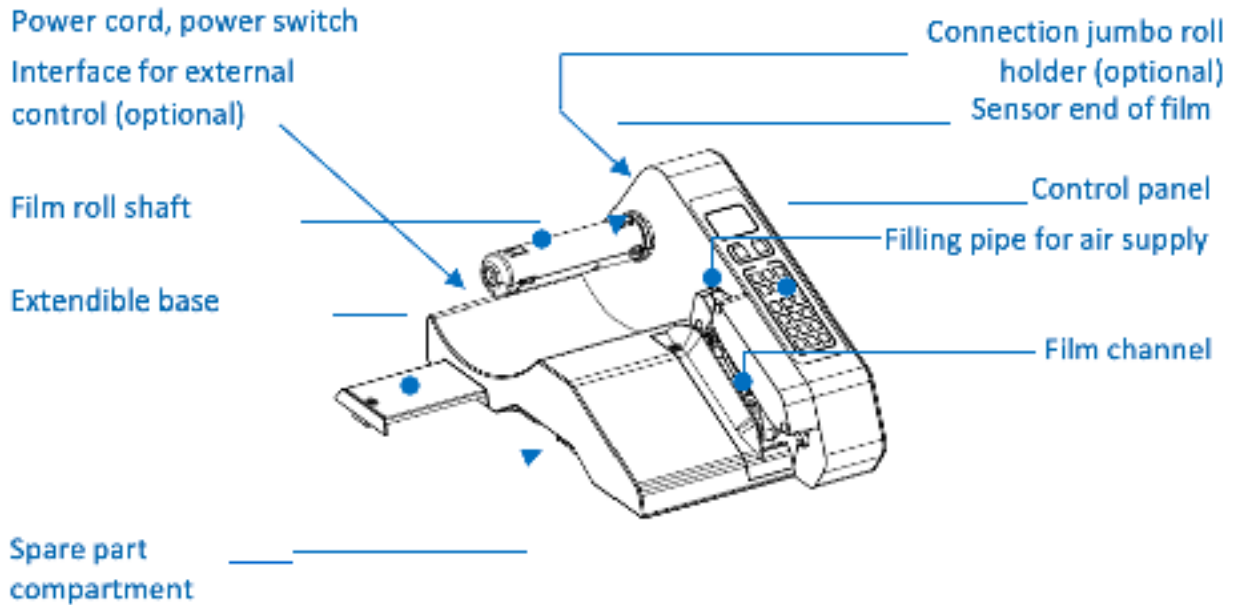

Technical Data

Power Supply:	120 V; 60 Hz
Power Consumption:	115 W (20 W Stand-By)
Production Speed:	26-32 ft./min
Weight:	12.3 lbs
Color:	Standard: anthracite/blue
Pod 2000 dimensions (LxWxH):	16 x 12.5 x 9 in (extendable leg additional 6in)

OPERATING INSTRUCTIONS

INCLUDED SPARE PARTS



Hex Key (4 piec-



Teflon belts (1 piec-



Knife (1 piece)



Power cord (1



Fuse (1 piece)



Film guide pins (2 piec-

OPERATING INSTRUCTIONS

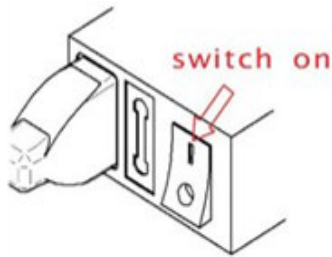

Connect power to the machine and switch on the machine.



The start screen will appear automatically after approximately 5 seconds on the control panel.

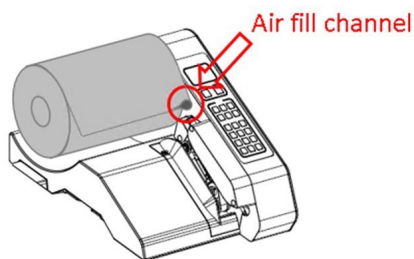

Load the roll of film on to the film roll shaft. Please note the side of air fill channel of the film. The channel must be on the side closest to the machine.

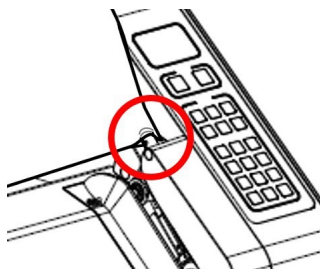

Guide the air fill channel of the film onto the air nozzle. Slide the film on the air nozzle a few more inches forward in the direction of sealing unit. That will simplify the next step.

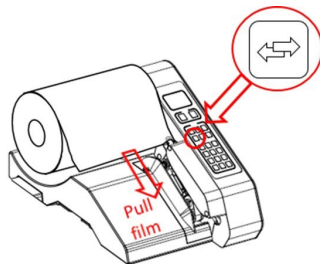

Pull the film above the air nozzle and through the film channel. Press the yellow feed button and pull the film all the way through. Press the green button to start.



Scan QR code for recommended settings

Use the control panel to set the sealing temperature, film length, and air volume. Once a roll of film is loaded and all settings are correct, press "Start" to start the production of air cushions.

Setting the sealing temperature S.T 338 °F

To change the sealing temperature, press SET and enter the required temperature. Press ENTER to continue and ESC to end adjustment function. The machine will start heating-up or cooling down to required temperature. During this process the display will show the flashing symbol ○.

The progress bar displays the current status of sealing temperature like a thermometer. Once the machine reaches the set temperature, the symbol ○ will change to ●.

The machine will start only when set temperature is reached. If the START button has been pressed during heating or cooling process, the machine would be in waiting mode and would start production when the target temperature has been reached.

Setting the film length Set 000 F

The length of the air cushion chain can be preset in feet, as desired. This value is set to 0 by default, which tells the machine to produce air cushions continuously. Press the "SET" button three times and enter the requested length. Press ENTER to continue and ESC to end the adjustment function. Press "START" to start the machine. The machine will stop automatically once the preset length has been reached.

Setting the air volume A.V 068 %

Set the air volume you want by pressing the buttons "+" and "-" next to the display. The air volume can be set between 0-100%. Use the recommended air volume for the respective film types.



OPERATING INSTRUCTIONS

Preset and Lock Function

Four presets with temperature, air volume and blowing time are possible for a quick selection. Programming the presetting can be done at programming level.

To program or change a preset press 2-3 sec. "0" and enter "4-5-6". Press "SET" to get to the requested value. Adjust the setting and press "ENT" to continue



Factory-adjusted: M1 for type 7.1 PE-Film 20µm; M2 for type 8.3 PE-Film 20µm.

For quick selection you have to be at foreman / control level. Press long time the number of requested program position and settings will be set. 1, 2, 3 or 4.

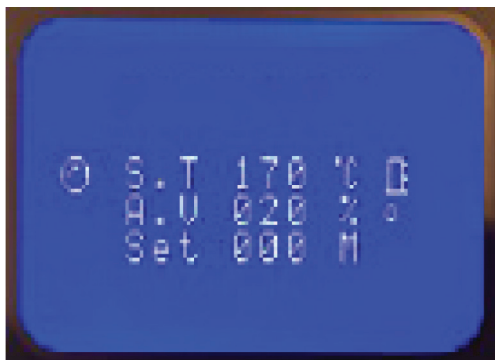

Control panel can be locked, to prevent setting changes by unauthorized person.



OPERATING INSTRUCTIONS

Change the Knife

You can easily change the knife for Pod 2000 yourself.

Step 1: Switch off the machine and disconnect power.



Always switch off the machine before opening it.



Disconnect power to the machine by removing the power cord completely from the machine.

Allow the machine to cool down!



Only the open the machine casing on the right side.

- Unscrew the screws with provided hex key.
- Hold cover at the bottom and remove cover with a little tilting movement.



You must follow this step. It is for your safety.

Step 2: Remove the knife.



Undo the locating screw with the provided hex key.



Remove the blade bracket.

Caution! Even used blades are extremely sharp!

OPERATING INSTRUCTIONS

Step 3: Change blade.

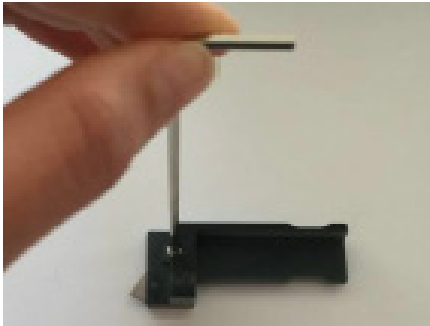

Undo the little screw which fixes the blade with the provided hex key.

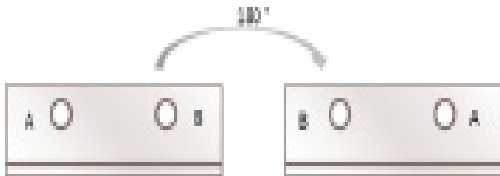

Turn around the blade one 180° or apply a new one if both sides were already used.



Fix the blade with the corresponding screw.

Step 4: Insert the Knife



Insert the knife into the slot at the machine casing and fix it with the screw.



Remount the cover at the top, close the machine casing and fix it with the screws.

OPERATING INSTRUCTIONS

Change the Transport Belts

You can easily change the Teflon belts for Pod 2000 yourself.

Step 1: Switch off and disconnect power.



Switch off the machine and disconnect power. Always switch off the machine before opening it. Disconnect power to the machine by removing the power cord completely from the machine. **Allow the machine to cool down!**

Step 2: Remove covers.

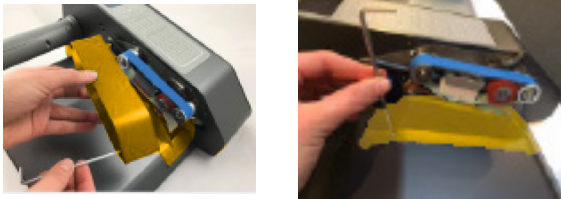

Undo screws and remove the upper cover first and after that the lower cover.

Step 3: Loosen transport rolls.

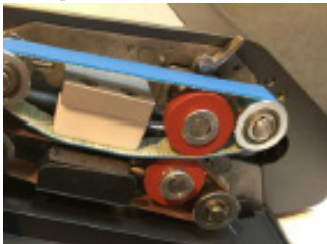

Turn the tension lever to move the transport rolls apart.

Step 4: Release transport / Teflon belt



Same steps for transport as for Teflon belt: Push the upper hinder guiding roll toward the one in the front against the spring and release the tension for the transport belt. Remove the slackened transport belt.

OPERATING INSTRUCTIONS

Step 5: Insert new transport / Teflon belt



Same steps for transport as for Teflon belt: Place the new belt over the hinder transport roll, push the roll toward the roll in the front place the belt over the front roll and loosen the pressure. Gently turn the rollers to check whether the belt is situated correctly between the seal pads. The belt should be able to move free.

Step 6: Tension the belts, close the machine.

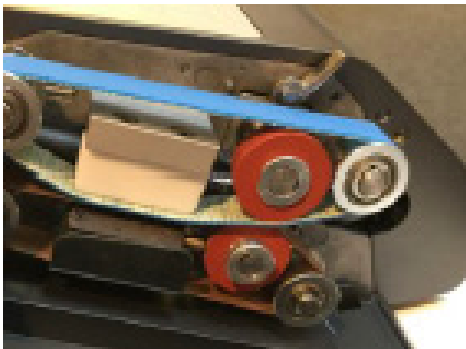

Turn the tension lever back to the left to press the transport rolls against each other.

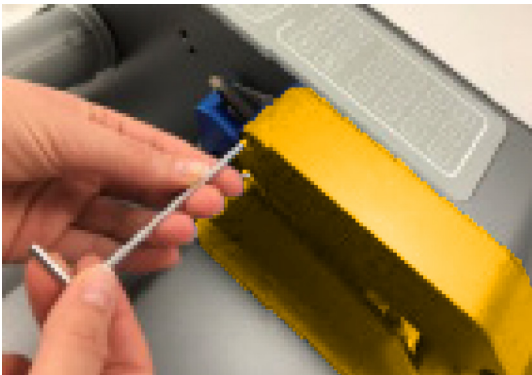

Fit the covers of the Teflon belts and screw it with the prepared hex key. Lower cover first and then the upper one.



Now you can reconnect the power cord and switch on the machine.

OPERATING INSTRUCTIONS

Change the Counter Pressure Block

The counter pressure block of Pod 2000 can easily be changed by yourself.



Switch off the machine and disconnect power.

Always switch off the machine before opening it. Disconnect power to the machine by removing the power cord completely from the machine.



Allow the machine to cool down!

Step 1: Remove the covers.



Undo screws and remove the upper cover first and after that the lower cover.

Step 2: Loosen transport rolls.



Turn the tension lever to move the transport rolls apart.

Step 3: Change Teflon block.



Unscrew counter pressure block and remove.



Replace counter pressure block with a new and fasten the screws.

OPERATING INSTRUCTIONS

Film Guide Pins

For a more effective air volume or better film guide for the film Types 8.3-8.5 use the two guiding pins.



Screw the pins at the machine casing.



Thread the film through the pins and over the airpipe.
Start production.

Error Codes

The Pod 2000 has an integrated diagnostic program. In the event of an error, an "E" code will appear on the display. This code will help you correct the error:

"Foil Empty": Film roll empty.

"Check Foil": Refeed film on to the airpipe.

"Heat Error": Please contact HoneyPack if this error occurs repeatedly or if it would not be possible to quit.

OPERATING INSTRUCTIONS

Options and Expandability

Please contact your sales advisor for further information.



Distance controlled production by Bluetooth connection. With tablet or smartphone.

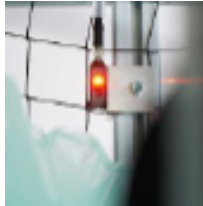

Fully automated control by the installation of a filling level sensor.

Optimal for overhead compartment or mobile air cushion storage.



Start-/Stop function with foot pedal.

For a production on demand. Even if you have no free hand or if machine is inaccessible.



Jumbo roll holder for bigger rolls.



Overhead Solution

For an automated air cushion stockage in ideal working height.



Docking station

For a decentralized consumption with mobile rolling container completely independent of machine position.



The large roll coiler

For the production of endless rolled sheets of the cushion mats.



Roll trough

For an easy storage of endless rolled sheets in optimum height.

OPERATING INSTRUCTIONS

Maintenance & Cleaning

The Pod 2000 is a low maintenance machine.

Mechanically claimed parts can show traces of abrasion after certain operating time. Furthermore there can occur contamination or residue of the HoneyPack Pod 2000.

Our recommendation:

All 30 roll changes and on demand.

- 1) Check Teflon belts and replace as the circumstances require.
- 2) Check red transport rolls regarding contamination and grip clean or replace if necessary.
- 3) The gear wheels always need to be sufficiently greased.



- 4) Check knife, see the cutting of the film, if necessary turn 180° or replace.
- 5) If necessary clear the machine of contamination and residue of film.
Consider also knife slot at air pipe, sealing block and other areas of the

All 100 roll changes.

- 6) Check transport belt and counter pressure block and replace as the circumstances require.

Warranty

Pod 2000 has a 12-month manufacturer's warranty that covers all electronic and mechanical components. The warranty period starts automatically when you purchase the machine.

In the event of damage, please contact our office.

If the machine needs to be sent back to us, please follow the steps discussed with our service team.

Your machine will be returned to you immediately once the repair is finished.

If you need a replacement machine, the warranty period will continue from the receipt date of the first machine. The warranty will not be extended.

Warranty does not include the following:

- Damage resulting from improper use of Pod 2000.
- This includes damage caused by using unsuitable films or inserting foreign objects into the machine's transport belt.
- Wear and tear caused by regular use.
- Wearing parts such as Teflon transport belts, knives, and transport rollers.
- Damage caused by machine downtimes.

OPERATING INSTRUCTIONS

Operational Guide Pins



When running low profile wrapping products, please install the guide pins for the best results.

Thread the film through the pins and over the airpipe as detailed previously.

Optional PaperPack Ring



When running PaperPack products, install the spacer ring onto the spindle.

HONEY PACK

UNPACKING NEW POSSIBILITIES.



Need additional support and service? Scan the QR code.

 844.466.3972

 honeypack.com